

三通/五通先导式电磁阀(低功率)

3 Way & 5 Way Pilot Type Solenoid Valve

TSVE400/420 Series

图形符号

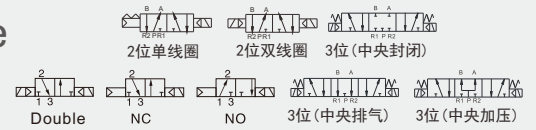

PNEUMATICS

2



Common Specification (共同规格)

Model (型号)	TSVE400	TSVE420(B)	TSVE420C/E/P
	二位三通	二位五通	三位五通
Effective Sectional Area (有效截面积)	30mm ² (CV=1.68)		18mm ² (CV=1.0)
Working Medium (工作介质)	5 Micron Filtered Air(经5 微米过滤的空气)		
Operating Temp. (工作温度)	-5~+60°C		
Motion Pattern (动作方式)	Inner Guide Type (内部先导式)		
Working-pressure(使用压力)	0.15~0.8MPa		
Max. Pressure Resistance(最大耐压力)	1.2MPa		
Voltage Range (电压范围)	±10%		
Power Consumption(耗电量)	AC: 2.5VA DC: 1W		
Insulation & Protection Class(绝缘性及防护等级)	F级. IP65 / F Class. IP65		
Highest Action Frequency(最高动作频率)	5 Cycle / Sec (每秒五次)		
Shortest Excitation Time(最短励磁时间)	0.05秒 Second		
Connection(接电方式)	Grommet(直接出线式)		
Port Size(接管口径)	G1/2"		

*Please Use Tubine Oil 1st-grade ISO VG32#,If Required. 若需要润滑油请使用透平1号油ISOVG32

How To Order (型号表示方法)

3WAY
TSVE400 - **5** **GZ-04** **A**

5WAY
TSVE420 - **5** **GZ-03**

Solenoid 电磁线圈		Rated Voltage 额定电压		Initial State 初始状态	
Nil(空)	Single(单线圈)	3	AC110V	A	NC(常闭)
B	Double(双线圈)	4	AC220V	B	NO(常开)
		5	DC24V		
		6	DC12V		

Solenoid 电磁线圈		Rated Voltage 额定电压	
Nil(空)	Single(单线圈)	3	AC110V
B	Double(双线圈)	4	AC220V
C	Closed Center(中央封闭)	5	DC24V
E	Exhaust Center(中央排气)	6	DC12V
P	Press.Center(中央加压)		

Dimensions(mm) (外形尺寸图(毫米))

TSVE400-□GZ-04A/B

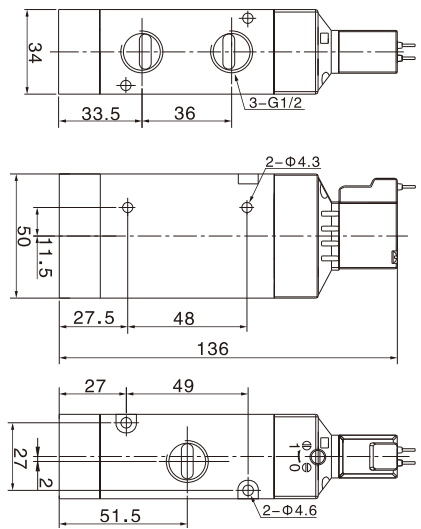

TSVE400B-□GZ-04A/B

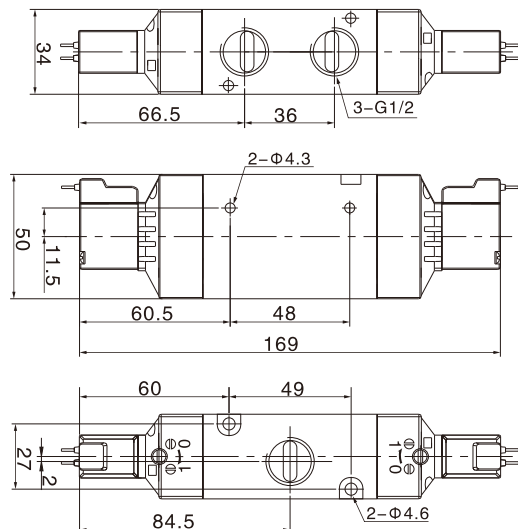

三通/五通先导式电磁阀(低功率)

3 Way & 5 Way Pilot Type Solenoid Valve

TSVE400/420 Series

Dimensions(mm) (外形尺寸图(毫米))

TSVE420-□GZ-04

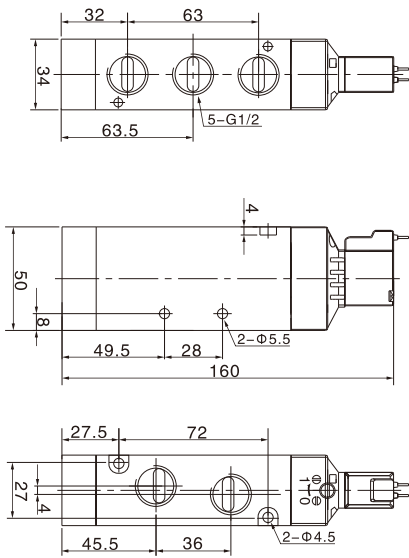

TSVE420B-□GZ-04

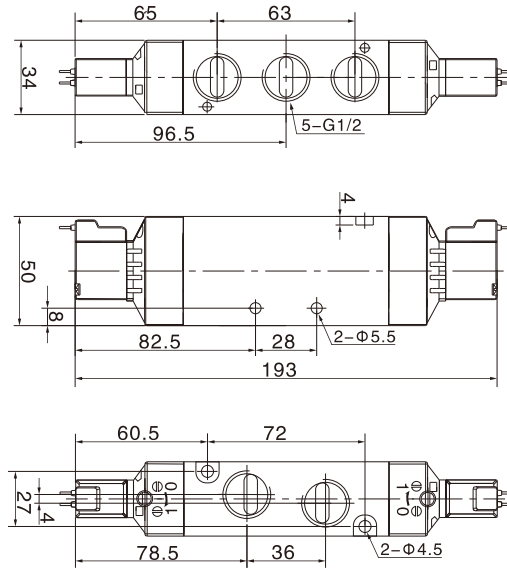

TSVE420^C_{PE}-□GZ-04

